

Minotti

COLLAR DESIGN RODOLFO DORDONI



IL SISTEMA DI SEDUTE COLLAR È CARATTERIZZATO DALLA POSSIBILITÀ DI MUOVERE IN MANIERA INDIPENDENTE I BRACCIOLI E GLI SCHIENALI IN TRE DIVERSE POSIZIONI. UN DETTAGLIO DI METALLO, SAGOMATO E VERNICIATO COLOR PELTRO, DECORA E DELINEA LA PARTE DEL BRACCIOLO E DELLO SCHIENALE ATTI AL MOVIMENTO.

STRUTTURA: SCHIENALI E BRACCIOLI IN METALLO CON CINGHIE ELASTICHE AD ALTA COMPONENTE DI CAUCCIÙ, ANNEGATI IN SCHIUMA POLIURETANICA IGNIFUGA E ULTERIORE INSERTO A QUOTE DIFFERENZIALI IN MATERIALE TERMOSENSIBILE (MEMORY FOAM).

LE PARTI SUPERIORI DELLO SCHIENALE E DEL BRACCIOLO SONO RIVESTITE CON TRAPUNTINO IN PIUMA D'OCA CANALIZZATA CHE CONFERISCE MORBIDEZZA E SOFFICITÀ DANDO ALLO SCHIENALE E AL BRACCIOLO UN APPOGGIO ACCOGLIENTE.

SUCCESSIVO ULTERIORE RIVESTIMENTO IN FIBRA TERMOLEGATA TRASPIRANTE DI FORTE SPESSORE ED ACCOPPIATA CON TELA DI COTONE BIANCA ANALLERGICA.

STRUTTURA SEDILE IN LEGNO MASSELLO CON MOLLEGGIO GARANTITO DA CINGHIE ELASTICHE AD ALTA COMPONENTE DI CAUCCIÙ. PREPARAZIONE DELLA STRUTTURA IN POLIURETANO ESPANSO A QUOTE DIFFERENZIALI AD ALTA DENSITÀ.

CUSCINATURA: IMBOTTITURA CUSCINO SCHIENALE E SEDILE IN PIUMA D'OCA CANALIZZATA (CERTIFICATA ASSOPIUMA, ETICHETTA ORO) CON INSERTO CENTRALE IN POLIURETANO ESPANSO A QUOTE DIFFERENZIALI AD ALTA RESILIENZA. CUSCINI SEDILE COMPLETAMENTE REVERSIBILI.

SFODERABILITÀ: CUSCINI SEDILE, CUSCINI SCHIENALE E STRUTTURA COMPLETAMENTE SFODERABILI IN TUTTE LE VERSIONI (TESSUTO E PELLE). PRIMA DI PROCEDERE ALLA RIMOZIONE DELLE FODERE, PORTARE I BRACCIOLI E LO SCHIENALE IN "POSIZIONE ALTA" - 165° - E SUCCESSIVAMENTE ALLENTARE TUTTI I DETTAGLI DECORATIVI IN METALLO CHE SI TROVANO NELLA PARTE FRONTALE E RETRO DEI BRACCIOLI E DEGLI SCHIENALI.

PIEDINI: APPOGGIO A TERRA TRAMITE PIEDINI IN METALLO, FINITURA BLACK-NICKEL LUCIDA E SCIVOLANTI PROTETTIVI IN NYLON.

THE COLLAR SEATING SYSTEM IS DISTINCTIVE IN THAT THE ARMRESTS AND BACKREST CAN BE MOVED INDEPENDENTLY INTO THREE DIFFERENT POSITIONS. A DECORATIVE SHAPED, PEWTER COLOR METAL DETAIL OUTLINES THE PART OF THE ARMREST AND BACKREST THAT CAN BE MOVED.

FRAME: BACKRESTS AND ARMRESTS IN METAL WITH HIGH RUBBER CONTENT ELASTIC STRAP WEBBING, ENCASED IN FIRE RESISTANT POLYURETHANE FOAM, AND ADDITIONAL VARIABLE-DENSITY INSERT IN HEAT-SENSITIVE MEMORY FOAM.

THE UPPER PARTS OF THE BACKREST AND ARMREST ARE WRAPPED WITH CHanneled GOOSE DOWN QUILTING THAT ADDS FLUFFY SOFTNESS TO MAKE THE BACKREST AND ARMREST COMFORTABLE AND INVITING.

AN ADDITIONAL CASING IN VERY THICK BREATHABLE HEAT-BONDED FIBER PAIRED TO WHITE HYPOALLERGENIC COTTON CANVAS TICKING IS APPLIED.

SEAT FRAME IN SOLID WOOD WITH SPRING PROVIDED BY HIGH NATURAL RUBBER CONTENT ELASTIC STRAP WEBBING. PREPARATION OF THE STRUCTURE IN HIGH RESILIENCE VARIABLE-DENSITY POLYURETHANE FOAM.

CUSHIONS: CHanneled GOOSE DOWN (CERTIFIED ASSOPIUMA, GOLD LABEL) PADDING FOR BACKRESTS AND CUSHIONS WITH CENTER INSERT IN HIGH RESILIENCE VARIABLE-DENSITY POLYURETHANE FOAM. SEAT CUSHIONS ARE COMPLETELY REVERSIBLE.

COVERS: SEAT CUSHIONS, BACKREST AND STRUCTURAL COVERS ARE COMPLETELY REMOVABLE IN ALL VERSIONS (FABRIC AND LEATHER). BEFORE REMOVING COVERS, BRING THE ARMRESTS AND BACKREST TO THE "HIGH POSITION" - 165° - AND THEN LOOSEN THE DECORATIVE METAL TRIM FOUND ON THE FRONT AND BACK OF THE ARMRESTS AND BACKRESTS.

FEET: METAL FEET WITH POLISHED BLACK-NICKEL FINISH AND PROTECTIVE NYLON SLIDES.

DAS SITZPROGRAMM COLLAR ZEICHNET SICH DURCH DIE MÖGLICHKEIT AUS, ARM- UND RÜCKENLEHNEN UNABHÄNGIG VONEINANDER IN DREI VERSCHIEDENE POSITIONEN ZU BRINGEN. EINE ZINNFARBIG LACKIERTE METALLSTANGE KENNZEICHNET IN DEKORATIVER WEISE DEN BEWEGLICHEN TEIL DER ARM- UND RÜCKENLEHNE.

STRUKTUR: ARM- UND RÜCKENLEHNEN MIT ELASTISCHEN RIEMEN MIT HOHEM KAUSCHUKANTEIL, EINGEBETTET IN FEUERFESTEN POLYURETHANSCHAUM MIT EINER ZUSÄTZLICHEN EINLAGE AUS UNTERSCHIEDLICH DICK GESCHÄUMTEM, WÄRMESENSIBLEM MATERIAL (MEMORY FOAM).

DER OBERE TEIL DER ARM- UND RÜCKENLEHNEN SIND MIT EINEM LEICHT GESTEPPTEN, MIT KANALISIERTEN GÄNSEDÄUNEN GEFÜLLTEN STOFF BEZOGEN, DER MIT SEINER LÖCKEREN WEICHHEIT DIE RÜCKEN- UND ARMLEHNE ZUR SCHMIEGSAMEN STÜTZE MACHT.

DARÜBER EIN WEITERER DICKER, ATMUNGSAKTIVER THERMOFASERBEZUG KOMBINIERT MIT ANTIALLERGISCHEM WEISSEM BAUMWOLLSTOFF.

STRUKTUR DES SITZES AUS MASSIVHOLZ, GEFEDERT MIT ELASTISCHEN RIEMEN MIT HOHEM KAUSCHUKANTEIL. AUFBEREITUNG DES GESTELLS MIT UNTERSCHIEDLICH DICK GESCHÄUMTEM, HOCHDICHEM POLYURETHAN.

KISSEN: POLSTERUNG DER RÜCKEN- UND SITZKISSEN MIT KANALISIERTEN GÄNSEDÄUNEN (ZERTIFIZIERUNG ASSOPIUMA, GOLDETIKETT) MIT ZENTRALEM EINSATZ AUS UNTERSCHIEDLICH DICK GESCHÄUMTEM, HOCHDICHEM POLYURETHAN. SITZKISSEN BEIDSEITIG BENUTZBAR.

ABZIEHBARKEIT: SITZ-, RÜCKENKISSEN UND STRUKTUR SIND IN ALLEN AUSFÜHRUNGEN (STOFF UND LEDER) VOLLKOMMEN ABZIEHBAR. VOR DEM ABZIEHEN ARM- UND RÜCKENLEHNEN IN DIE VERTIKALE POSITION BRINGEN - 165° - UND DANN ALLE DEKORATIVEN METALLTEILE AN VORDER- UND RÜCKSEITE DER ARM- UND RÜCKENLEHNEN LÖCKERN.

FÜSSE: BODENAUFBLAGE MIT KLEINEN METALLFÜSSEN IN GLÄNZENDEM BLACK-NICKEL-FINISH UND MIT GLEITSCHUTZ AUS NYLON.

LE SYSTÈME DE SIÈGES COLLAR EST CARACTÉRISÉ PAR LA POSSIBILITÉ DE RABATTRE OU DE RELEVER INDÉPENDAMMENT LES PARTIES MOBILES DES ACCOUDOIRS ET DES DOSSIERS DANS TROIS DIFFÉRENTES POSITIONS. UN DÉTAIL EN MÉTAL, PROFILÉ ET PEINT COULEUR ÉTAÏN, DÉCORE ET DESSINE LA PARTIE DE L'ACCOUDOIR ET DU DOSSIER APTE AU MOUVEMENT.

STRUCTURE: DOSSIERS ET ACCOUDOIRS EN MÉTAL, AVEC SANGLES ÉLASTIQUES À HAUTE TENEUR EN CAOUTCHOUC, NOYÉS DANS UNE MOUSSE POLYURÉTHANE IGNIFUGE ET INSERT SUPPLÉMENTAIRE À ÉPAISSEURS DIFFÉRENTES EN MOUSSE THERMOSENSIBLE À MÉMOIRE DE FORME (MEMORY FOAM).

LES PARTIES SUPÉRIEURES DU DOSSIER ET DE L'ACCOUDOIR SONT DOUBLÉES D'UNE PETITE COUETTE EN PLUME D'OIE CANALISÉE, QUI DONNE PLUS DE SOUPLÉSSE ET DE MOELLEUX, GARANTISSANT UN APPUI ACCUEILLANT DU DOSSIER ET DE L'ACCOUDOIR.

SECOND REVÊTEMENT EN FIBRE THERMOLIÉE RESPIRANTE DE FORTE ÉPAISSEUR, DOUBLÉE DE TOILE DE COTON BLANC ANALLERGIQUE.

STRUCTURE DE L'ASSISE EN BOIS MASSIF AVEC SUSPENSION GARANTIE PAR DES SANGLES ÉLASTIQUES À HAUTE TENEUR EN CAOUTCHOUC. PRÉPARATION DE LA STRUCTURE EN POLYURÉTHANE EXPANSÉ À ÉPAISSEURS DIFFÉRENTES, À HAUTE DENSITÉ.

COUSSINS: REMBOURAGE COUSSIN DU DOSSIER ET DE L'ASSISE EN PLUME D'OIE CANALISÉE (CERTIFIÉE ASSOPIUMA, ÉTIQUETTE OR) AVEC INSERT CENTRAL EN POLYURÉTHANE EXPANSÉ À HAUTEURS DIFFÉRENTES À HAUTE RÉSILIENCE. COUSSINS DE L'ASSISE ENTIÈREMENT RÉVERSIBLES.

DÉHOUSSAGE: COUSSINS DE L'ASSISE, COUSSINS DU DOSSIER ET STRUCTURE ENTIÈREMENT DÉHOUSSABLES DANS TOUTES LES VERSIONS (TISSU ET CUIR). AVANT D'EFFECTUER LE DÉHOUSSAGE, AMENER LES ACCOUDOIRS ET LE DOSSIER DANS LA "POSITION HAUTE" - 165° - PUIS DESSERRER TOUS LES DÉTAILS DÉCORATIFS EN MÉTAL QUI SE TROUVENT À L'AVANT ET À L'ARRIÈRE DES ACCOUDOIRS ET DES DOSSIERS.

PIEDS: APPUI AU SOL PAR PIEDS EN MÉTAL, FINITION BLACK-NICKEL BRILLANTE, ET PATINS DE PROTECTION EN NYLON.

COLLAR SEATING SYSTEM

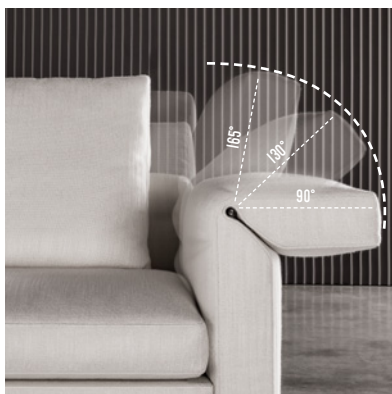

COLLAR È RISULTATO CONFORME ALLE SEGUENTI VERIFICHE UNI COLLAR HAS PASSED THE FOLLOWING UNI TESTS

UNI EN 12520:2010 par. 5.4.1.1
CARICO STATICO SEDILE E SCHIENALE
STATIC LOAD ON SEAT AND BACK

UNI EN 12520:2010 par. 5.4.1.2
CARICO STATICO DEL BORDO ANTERIORE
STATIC LOAD ON FRONT EDGE

UNI EN 12520:2010 par. 5.4.1.6
PROVA DI FATICA SEDILE E SCHIENALE
FATIGUE TEST ON SEAT AND BACK

UNI EN 12520:2010 par. 5.4.1.7
PROVA DI FATICA DEL BORDO ANTERIORE
FATIGUE TEST ON FRONT EDGE

UNI EN 12520:2010 par. 5.4.1.11
IMPATTO SULLA SEDUTA
IMPACT ON SEAT

UNI EN 16139:2013 + EC 1-2013 UNI EN 16139:2013 par. 6.5
PROVA DI CARICO STATICO LATERALE SUL BRACCIOLO
STATIC LOAD TEST ON SIDE OF ARMREST

UNI EN 16139:2013 + EC 1-2013 UNI EN 16139:2013 par. 6.6
PROVA DI CARICO STATICO VERSO IL BASSO SUL BRACCIOLO
STATIC LOAD TEST TOWARDS BOTTOM OF ARMREST

UNI EN 16139:2013 + EC 1-2013 UNI EN 16139:2013 par. 6.10
PROVA DI DURATA SUI BRACCIOLI
ENDURANCE TEST ON ARMRESTS

UNI EN 16139:2013 + EC 1-2013 UNI EN 16139:2013 par. 6.16
PROVA D'URTO SUL BRACCIOLO
IMPACT RESISTANCE TEST ON ARMREST

UNI EN 16139:2013 + EC 1-2013 UNI EN 16139:2013 par. 6.1
PROVA DI CARICO STATICO SUL SEDILE E SULLO SCHIENALE
STATIC LOAD TEST ON SEAT AND BACK

UNI EN 16139:2013 + EC 1-2013 UNI EN 16139:2013 par. 6.3
CARICO STATICO VERTICALE SCHIENALE
VERTICAL STATIC LOAD ON BACK

UNI EN 16139:2013 + EC 1-2013 UNI EN 16139:2013 par. 6.8
PROVA DI DURATA SUL SEDILE E SULLO SCHIENALE
ENDURANCE TEST ON SEAT AND BACK

UNI EN 16139:2013 + EC 1-2013 UNI EN 16139:2013 par. 6.15
PROVA D'URTO SULLO SCHIENALE
IMPACT RESISTANCE TEST ON BACK

MOVIMENTO SCHIENALE E BRACCIOLO

IL SISTEMA DI SEDUTE COLLAR È CARATTERIZZATO DALLA POSSIBILITÀ DI MUOVERE IN MANIERA INDIPENDENTE I BRACCIOLI E GLI SCHIENALI.

TRE LE POSIZIONI DISPONIBILI:

1. BRACCIOLO E/O SCHIENALE A 90° - POSIZIONE BASE

LA PARTE MOVIBILE DEL BRACCIOLO E/O DELLO SCHIENALE RISULTA ESSERE POSIZIONATA A 90° RISPETTO AL FIANCO DEL DIVANO;

2. BRACCIOLO E/O SCHIENALE A 130° - POSIZIONE INTERMEDIA

LA PARTE MOVIBILE DEL BRACCIOLO E/O DELLO SCHIENALE RISULTA ESSERE POSIZIONATA A 130° RISPETTO AL FIANCO DEL DIVANO (MOVIMENTO DI +40° RISPETTO ALLA POSIZIONE BASE);

3. BRACCIOLO E/O SCHIENALE A 165° - POSIZIONE ALTA

LA PARTE MOVIBILE DEL BRACCIOLO E/O DELLO SCHIENALE RISULTA ESSERE POSIZIONATA A 165° RISPETTO AL FIANCO DEL DIVANO (MOVIMENTO DI +35° RISPETTO ALLA POSIZIONE INTERMEDIA);

PER RIPORTARE IL BRACCIOLO E/O LO SCHIENALE IN POSIZIONE BASE O IN POSIZIONE INTERMEDIA EFFETTUARE LO SBLOCCO DEL MECCANISMO ALZANDO LA PARTE MOVIBILE FINO A 180° E ABBASSARLA SUCCESSIVAMENTE CON DELICATEZZA RIPORTANDOLA IN POSIZIONE BASE.

BACKREST AND ARMREST MOVEMENT

THE COLLAR SEATING SYSTEM IS DISTINGUISHED BY THE POSSIBILITY OF MOVING THE ARMREST AND BACKREST INDEPENDENTLY.

THERE ARE THREE POSITION OPTIONS:

1. ARMREST AND/OR BACKREST AT 90° - BASE POSITION

THE MOVABLE PART OF THE ARMREST AND/OR THE BACKREST IS POSITIONED AT A 90° ANGLE TO THE SIDE OF THE SOFA;

2. ARMREST AND/OR BACKREST AT 130° - INTERMEDIATE POSITION

THE MOVABLE PART OF THE ARMREST AND/OR THE BACKREST IS POSITIONED AT A 130° ANGLE TO THE SIDE OF THE SOFA (MOVEMENT OF +40° WITH REGARD TO THE BASE POSITION);

3. ARMREST AND/OR BACKREST AT 165° - HIGH POSITION

THE MOVABLE PART OF THE ARMREST AND/OR THE BACKREST IS POSITIONED AT A 165° ANGLE TO THE SIDE OF THE SOFA (MOVEMENT OF +35° WITH REGARD TO THE INTERMEDIATE POSITION);

TO RETURN THE ARMREST AND/OR THE BACKREST TO BASE POSITION OR TO THE INTERMEDIATE POSITION, UNLOCK THE MECHANISM BY LIFTING THE MOVABLE PART UP TO 180° AND THEN CAREFULLY AND GENTLY LOWERING IT BACK TO THE BASE POSITION.

VERSTELLBARE RÜCKEN- UND ARMLEHNE

DAS SITZPROGRAMM COLLAR ZEICHNET SICH DURCH DIE MÖGLICHKEIT AUS, ARM- UND RÜCKENLEHNEN UNABHÄNGIG VONEINANDER ZU VERSTELLEN.

DREI VERSCHIEDENE STELLUNGEN:

1. ARM- UND/ODER RÜCKENLEHNE IM 90° WINKEL - AUSGANGSPOSITION

DER VERSTELLBARE TEIL DER ARM- UND/ODER RÜCKENLEHNE BEFINDET SICH IM 90° WINKEL ZUM SEITENTEIL DES SOFAS;

2. ARM- UND/ODER RÜCKENLEHNE MIT EINER NEIGUNG VON 130° - ZWISCHENPOSITION

DER VERSTELLBARE TEIL DER ARM- UND/ODER RÜCKENLEHNE BEFINDET SICH IM 130° WINKEL ZUM SEITENTEIL DES SOFAS (NEIGUNG VON +40° GEGENÜBER DER AUSGANGSPOSITION);

3. ARM- UND/ODER RÜCKENLEHNE IM 165° WINKEL - VERTIKALE POSITION

DER VERSTELLBARE TEIL DER ARM- UND/ODER RÜCKENLEHNE BEFINDET SICH IM 165° WINKEL ZUM SEITENTEIL DES SOFAS (NEIGUNG VON +35° GEGENÜBER DER ZWISCHENPOSITION);

UM DIE ARM- UND/ODER RÜCKENLEHNE IN DIE AUSGANGSPOSITION ODER DIE ZWISCHENPOSITION ZURÜCK ZU BRINGEN, MUSS DER MECHANISMUS ENTBLOCKT WERDEN, INDEM DER VERSTELLBARE TEIL BIS ZU 180° HOCHGESTELLT UND DANN SANFT ZURÜCK IN DIE AUSGANGSPOSITION GEBRACHT WIRD.

MOUVEMENT DOSSIER ET ACCOUDOIR

LE SYSTÈME DE SIÈGES COLLAR EST CARACTÉRISÉ PAR LA POSSIBILITÉ DE RABATTRE OU DE RELEVER INDÉPENDAMMENT LES PARTIES MOBILES DES ACCOUDOIRS ET DES DOSSIERS.

TROIS POSITIONS DISPONIBLES :

1. ACCOUDOIR ET/OU DOSSIER À 90° - POSITION DE BASE

LA PARTIE MOBILE DE L'ACCOUDOIR ET/OU DU DOSSIER FAIT UN ANGLE DE 90° AVEC LE CÔTÉ DU CANAPÉ;

2. ACCOUDOIR ET/OU DOSSIER À 130° - POSITION INTERMÉDIAIRE

LA PARTIE MOBILE DE L'ACCOUDOIR ET/OU DU DOSSIER FAIT UN ANGLE DE 130° AVEC LE CÔTÉ DU CANAPÉ (MOUVEMENT DE +40° PAR RAPPORT À LA POSITION DE BASE);

3. ACCOUDOIR ET/OU DOSSIER À 165° - POSITION HAUTE

LA PARTIE MOBILE DE L'ACCOUDOIR ET/OU DU DOSSIER FAIT UN ANGLE DE 165° AVEC LE CÔTÉ DU CANAPÉ (MOUVEMENT DE +35° PAR RAPPORT À LA POSITION INTERMÉDIAIRE);

POUR RAMENER L'ACCOUDOIR ET/OU LE DOSSIER DANS LA POSITION DE BASE OU DANS LA POSITION INTERMÉDIAIRE, DÉBLOQUER LE MÉCANISME EN REMONTANT LA PARTIE MOBILE JUSQU'À 180° PUIS L'ABAISSER DÉLICATEMENT ET LA RAMENER DANS LA POSITION DE BASE.

GLI INGOMBRI DEI VARI ELEMENTI COLLAR VARIANO A SECONDA DELLE DIVERSE POSIZIONI ASSUNTE DAI BRACCIOLI E DAGLI SCHIENALI. LE MISURE RIPORTATE A CATALOGO INDICANO L'INGOMBRO TOTALE DELL'ELEMENTO CON BRACCIOLI E SCHIENALI IN POSIZIONE BASE (90°).

SPACE REQUIREMENTS FOR THE VARIOUS COLLAR ELEMENTS VARY DEPENDING ON THE POSITION OF THE ARMRESTS AND BACKRESTS. CATALOGUE MEASUREMENTS INDICATE THE TOTAL SPACE REQUIREMENT OF THE ELEMENT WITH THE ARMRESTS AND BACKRESTS IN THE BASE POSITION (90°).

DIE DIMENSIONEN DER EINZELNEN ELEMENTE VON COLLAR ÄNDERN SICH JE NACH DER POSITION DER ARM- UND RÜCKENLEHNEN. DIE IN DEM KATALOG ANGEGEBENEN MASSE BEZIEHEN SICH AUF DIE GESAMTDIMENSION DES ELEMENTS MIT ARM- UND RÜCKENLEHNEN IN AUSGANGSPOSITION (90°).

L'ENCOMBREMENT DES DIFFÉRENTS ÉLÉMENTS COLLAR VARIE SELON LES POSITIONS DES ACCOUDOIRS ET DES DOSSIERS. LES DIMENSIONS INDICUÉES SUR LE CATALOGUE SONT CELLES DE L'ENCOMBREMENT TOTAL DE L'ÉLÉMENT AVEC ACCOUDOIRS ET DOSSIERS DANS LA POSITION DE BASE (90°).

POSIZIONE | POSITION 1 (BASE | BASE)
BRACCIOLO/SCHIENALE | ARMREST/BACKREST 90°

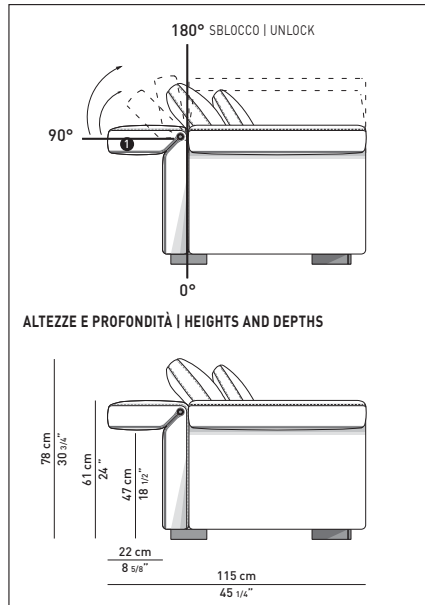

POSIZIONE | POSITION 2 (INTERMEDIA | INTERMEDIATE)
BRACCIOLO/SCHIENALE | ARMREST/BACKREST 130°

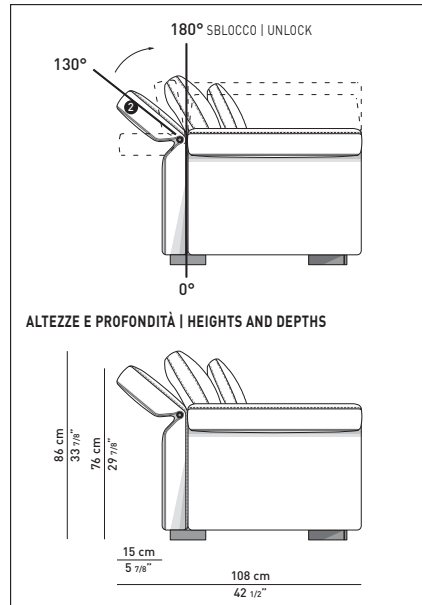

QUANDO L'ELEMENTO HA LO SCHIENALE IN POSIZIONE INTERMEDIA SI OTTIENE UNA RIDUZIONE DI PROFONDITÀ DI **CM 7** RISPETTO ALLA POSIZIONE BASE.

WHEN THE ELEMENT HAS THE BACKREST IN THE INTERMEDIATE POSITION THE OVERALL DEPTH REQUIRED IS REDUCED BY **CM 7** COMPARED TO THE BASE POSITION.

BEFINDET SICH DIE RÜCKENLEHNE IN ZWISCHENPOSITION, SO VERRINGERT SICH DIE GESAMSTIEFE UM **7 CM** GEGENÜBER DER AUSGANGSPOSITION.

QUAND LE DOSSIER EST DANS LA POSITION INTERMÉDIAIRE, ON OBTIEN UNE RÉDUCTION DE L'ENCOMBREMENT TOTAL EN PROFONDEUR DE L'ÉLÉMENT DE **7 CM** PAR RAPPORT À LA POSITION DE BASE.

POSIZIONE | POSITION 3 (ALTA | HIGH)
BRACCIOLO/SCHIENALE | ARMREST/BACKREST 165°

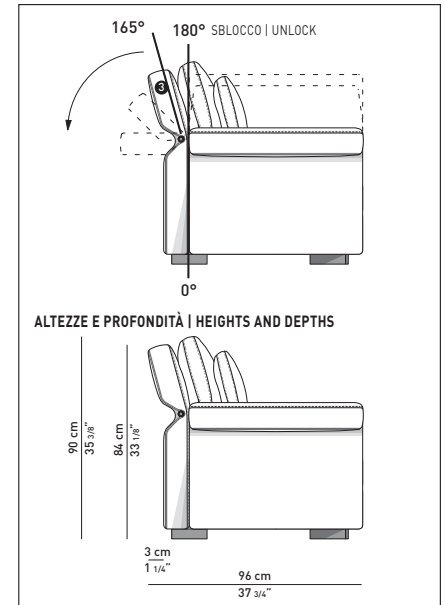

QUANDO L'ELEMENTO HA LO SCHIENALE IN POSIZIONE ALTA SI OTTIENE UNA RIDUZIONE DI PROFONDITÀ DI **CM 12** RISPETTO ALLA POSIZIONE INTERMEDIA E DI **CM 19** RISPETTO ALLA POSIZIONE BASE.

WHEN THE ELEMENT HAS THE BACKREST IN THE HIGH POSITION THE OVERALL DEPTH REQUIRED IS REDUCED BY **12 CM** COMPARED TO THE INTERMEDIATE POSITION AND BY **19 CM** COMPARED TO THE BASE POSITION.

BEFINDET SICH DIE RÜCKENLEHNE IN VERTIKALER POSITION, SO VERRINGERT SICH DIE GESAMSTIEFE UM **12 CM** GEGENÜBER DER ZWISCHENPOSITION UND UM **19 CM** GEGENÜBER DER AUSGANGSPOSITION.

QUAND LE DOSSIER EST DANS LA POSITION HAUTE, ON OBTIEN UNE RÉDUCTION DE L'ENCOMBREMENT EN PROFONDEUR DE L'ÉLÉMENT DE **12 CM** PAR RAPPORT À LA POSITION INTERMÉDIAIRE ET DE **19 CM** PAR RAPPORT À LA POSITION DE BASE.

POSIZIONE | POSITION 1 (BASE | BASE)
INGOMBRO | SPACE REQUIREMENT

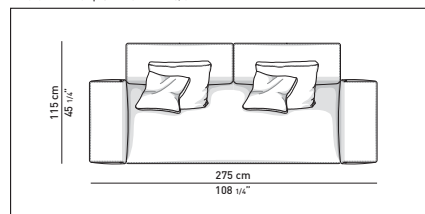

POSIZIONE | POSITION 2 (INTERMEDIA | INTERMEDIATE)
INGOMBRO | SPACE REQUIREMENT

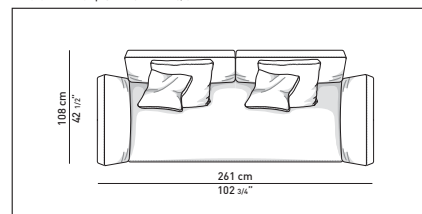

QUANDO L'ELEMENTO HA I BRACCIOLI IN POSIZIONE INTERMEDIA SI OTTIENE UNA RIDUZIONE D'INGOMBRO DI **CM 14 (7+7)** RISPETTO ALLA POSIZIONE BASE.

WHEN THE ELEMENT HAS THE ARMRESTS IN THE INTERMEDIATE POSITION THE SPACE REQUIRED IS REDUCED BY **14 (7+7) CM** COMPARED TO THE BASE POSITION.

BEFINDEN SICH ARMLEHNEN IN ZWISCHENPOSITION, SO VERRINGERT SICH DIE DIMENSION UM **14 (7+7) CM** GEGENÜBER DER AUSGANGSPOSITION.

QUAND L'ACCOUDOIR EST DANS LA POSITION INTERMÉDIAIRE, ON OBTIEN UNE RÉDUCTION DE L'ENCOMBREMENT DE L'ÉLÉMENT DE **14 (7+7) CM** PAR RAPPORT À LA POSITION DE BASE.

POSIZIONE | POSITION 3 (ALTA | HIGH)
INGOMBRO | SPACE REQUIREMENT

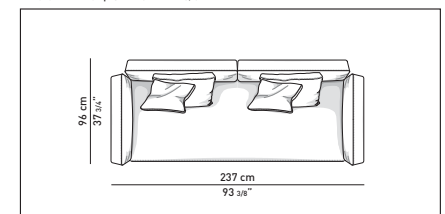

QUANDO L'ELEMENTO HA I BRACCIOLI IN POSIZIONE ALTA SI OTTIENE UNA RIDUZIONE D'INGOMBRO DI **CM 24 (12+12)** RISPETTO ALLA POSIZIONE INTERMEDIA E DI **CM 38 (19+19)** RISPETTO ALLA POSIZIONE BASE.

WHEN THE ELEMENT HAS THE ARMRESTS IN THE HIGH POSITION THE SPACE REQUIRED IS REDUCED BY **24 (12+12) CM** COMPARED TO THE INTERMEDIATE POSITION AND BY **38 (19+19) CM** COMPARED TO THE BASE POSITION.

BEFINDEN SICH ARMLEHNEN IN VERTIKALER POSITION, SO VERRINGERT SICH DIE DIMENSION UM **24 (12+12) CM** GEGENÜBER DER ZWISCHENPOSITION UND UM **38 (19+19) CM** GEGENÜBER DER AUSGANGSPOSITION.

QUAND L'ACCOUDOIR EST DANS LA POSITION HAUTE, ON OBTIEN UNE RÉDUCTION DE L'ENCOMBREMENT DE L'ÉLÉMENT DE **24 (12+12) CM** PAR RAPPORT À LA POSITION INTERMÉDIAIRE ET DE **38 (19+19) CM** PAR RAPPORT À LA POSITION DE BASE.

DIVANI | SOFAS

DIVANO CM 230
SOFA CM 230

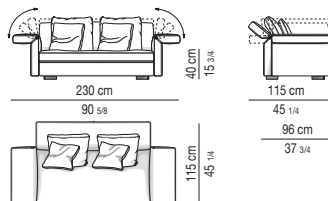

DIVANO CM 275
SOFA CM 275

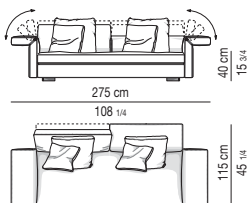

DIVANO CM 310
SOFA CM 310

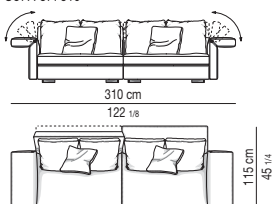

Divano composto da un elemento terminale sx da cm 155 e da un elemento terminale dx da cm 155.

Arrangement made up of one element with armrest sx cm 155 and one element with armrest dx cm 155.

DIVANO CM 315
SOFA CM 315

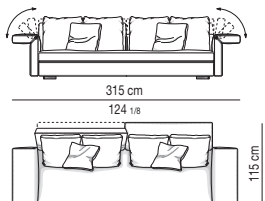

DIVANO CM 340
SOFA CM 340

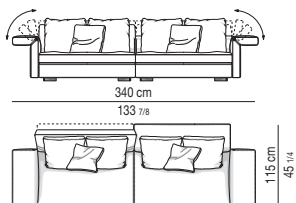

Divano composto da un elemento terminale sx da cm 170 e da un elemento terminale dx da cm 170.

Arrangement made up of one element with armrest sx cm 170 and one element with armrest dx cm 170.

DIVANO CM 390
SOFA CM 390

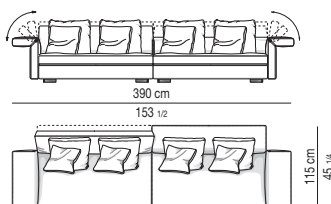

Divano composto da un elemento terminale sx da cm 195 e da un elemento terminale dx da cm 195.

Arrangement made up of one element with armrest sx cm 195 and one element with armrest dx cm 195.

DIVANI COMPOSTI | COMPOSED SOFAS

DIVANO COMPOSTO CM 350
COMPOSED SOFA CM 350

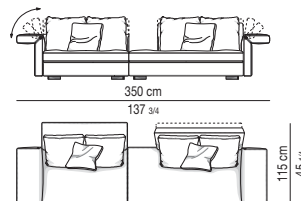

Divano composto da un elemento terminale sx da cm 155 e da un elemento terminale penisola dx da cm 195.

Arrangement made up of one element with armrest sx cm 155 and open-end element with armrest dx cm 195.

DIVANO COMPOSTO CM 355
COMPOSED SOFA CM 355

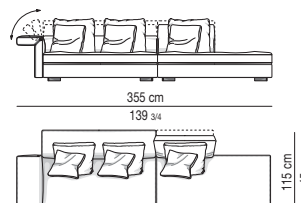

Divano composto da un elemento terminale sx da cm 195 e da un elemento penisola sx da cm 160. (schienale cm 80)

Arrangement made up of one element with armrest sx cm 195 and one open-end element sx cm 160. (backrest cm 80)

DIVANO COMPOSTO CM 365
COMPOSED SOFA CM 365

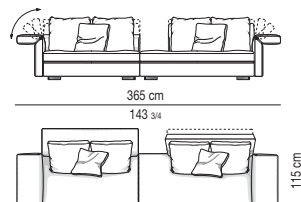

Divano composto da un elemento terminale sx da cm 170 e da un elemento terminale penisola dx da cm 195. (schienale cm 120)

Arrangement made up of one element with armrest sx cm 170 and one open-end element with armrest dx cm 195. (backrest cm 120)

POSIZIONE PIEDINI | FEET POSITION

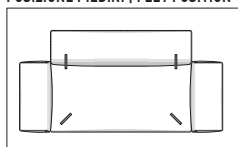

DIVANO COMPOSTO CM 390
COMPOSED SOFA CM 390

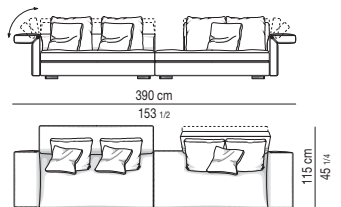

Divano composto da un elemento terminale sx da cm 195 e da un elemento terminale penisola dx da cm 195. (schienale cm 120)

Arrangement made up of one element with armrest sx cm 195 and one open-end element with armrest dx cm 195. (backrest cm 120)

DIVANO COMPOSTO CM 435
COMPOSED SOFA CM 435

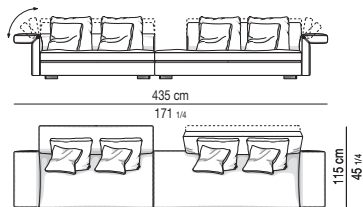

Divano composto da un elemento terminale sx da cm 195 e da un elemento terminale penisola dx da cm 240. (schienale cm 160)

Arrangement made up of one element with armrest sx cm 195 and one open-end element with armrest dx cm 240. (schienale cm 160)

DIVANO OPEN CM 315 - SCHIENALE CM 120
OPEN SOFA CM 315 - BACKREST CM 120

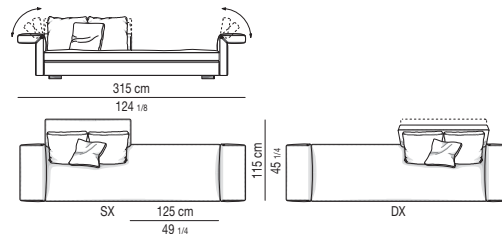

DIVANO OPEN CM 315 - SCHIENALE CM 160
OPEN SOFA CM 315 - BACKREST CM 160

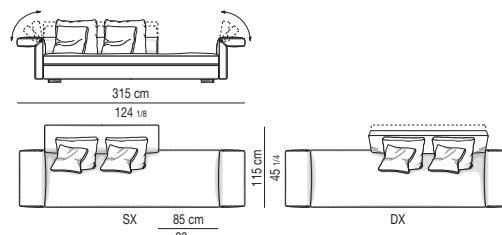

DIVANO COMPOSTO CM 400
COMPOSED SOFA CM 400

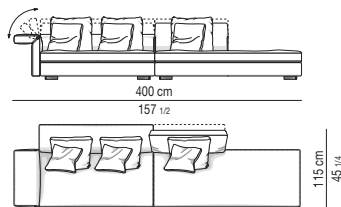

Divano composto da un elemento terminale sx da cm 195 e da un elemento penisola sx da cm 205. (schienale cm 100)

Arrangement made up of one element with armrest sx cm 195 and one open-end element sx cm 205. (backrest cm 100)

DIVANI OPEN | OPEN SOFAS

DIVANO OPEN CM 275 - SCHIENALE CM 100
OPEN SOFA CM 275 - BACKREST CM 100

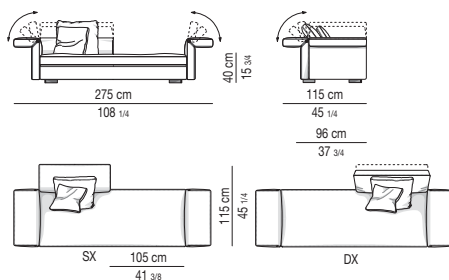

DIVANO OPEN CM 275 - SCHIENALE CM 160
OPEN SOFA CM 275 - BACKREST CM 160

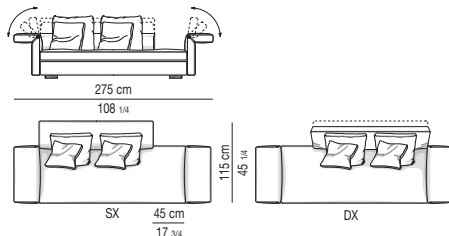

DIVANO COMPOSTO CM 435
COMPOSED SOFA CM 435

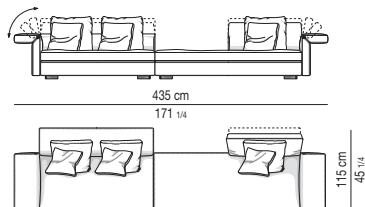

Divano composto da un elemento terminale sx da cm 195 e da un elemento terminale penisola dx da cm 240. (schienale cm 100)

Arrangement made up of one element with armrest sx cm 195 and one open-end element with armrest dx cm 240. (backrest cm 100)

ALTEZZE | HEIGHTS

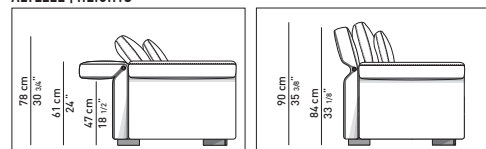

ELEMENTI TERMINALI | ELEMENTS WITH 1 ARMREST

ELEMENTO TERMINALE CM 135
ELEMENT WITH 1 ARMREST CM 135

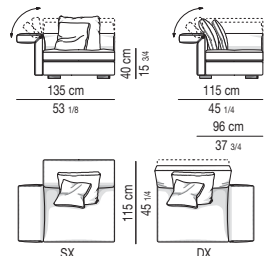

ELEMENTO TERMINALE CM 155
ELEMENT WITH 1 ARMREST CM 155

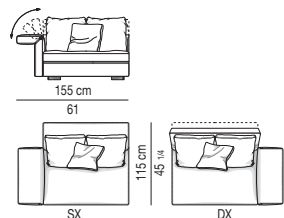

ELEMENTO TERMINALE CM 170
ELEMENT WITH 1 ARMREST CM 170

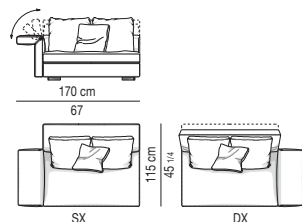

ELEMENTO TERMINALE CM 195
ELEMENT WITH 1 ARMREST CM 195

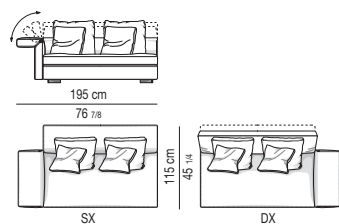

ELEMENTO TERMINALE CM 240
ELEMENT WITH 1 ARMREST CM 240

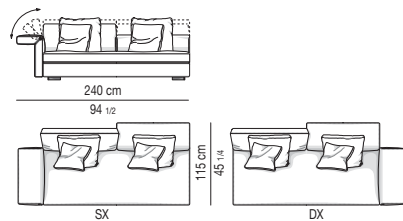

ELEMENTO TERMINALE CM 280
ELEMENT WITH 1 ARMREST CM 280

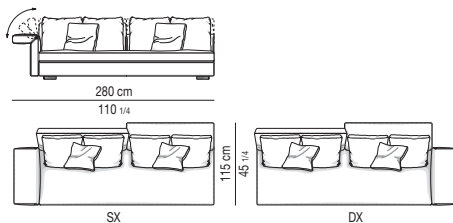

CHAISE-LONGUE

CHAISE-LONGUE CM 115X170

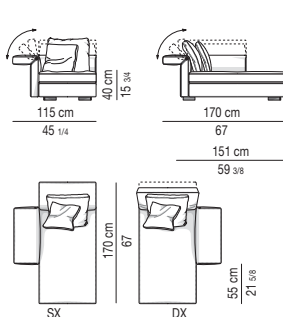

CHAISE-LONGUE CM 115X195

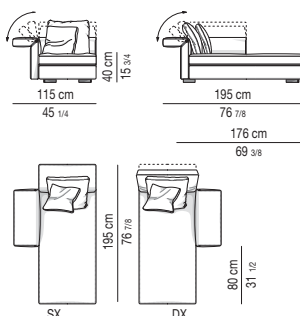

CHAISE-LONGUE CM 135X195

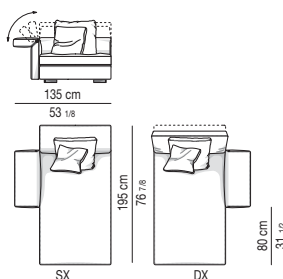

CHAISE-LONGUE CM 155X155 - BRACCIOLO CM 80
CHAISE-LONGUE CM 155X155 - ARMREST CM 80

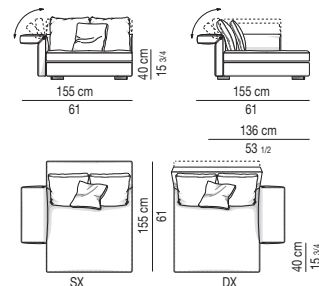

CHAISE-LONGUE CM 155X155 - BRACCIOLO CM 120
CHAISE-LONGUE CM 155X155 - ARMREST CM 120

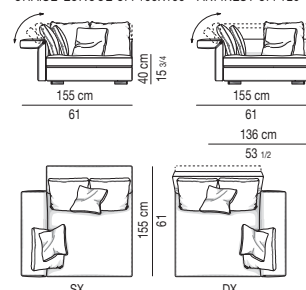

CHAISE-LONGUE CM 170X170 - BRACCIOLO CM 80
CHAISE-LONGUE CM 170X170 - ARMREST CM 80

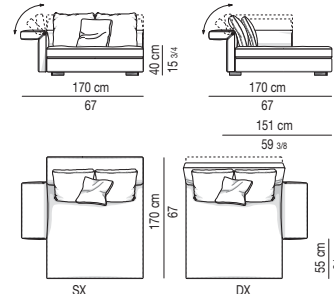

CHAISE-LONGUE CM 170X170 - BRACCIOLO CM 135
CHAISE-LONGUE CM 170X170 - ARMREST CM 135

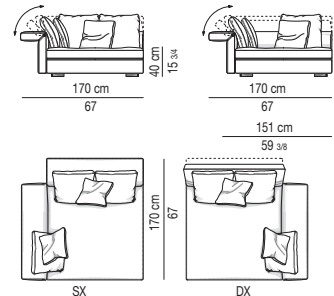

ALTEZZE | HEIGHTS

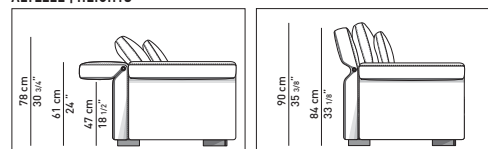

CHAISE-LONGUE CM 170X195 - BRACCIOLO CM 80
CHAISE-LONGUE CM 170X195 - ARMREST CM 80

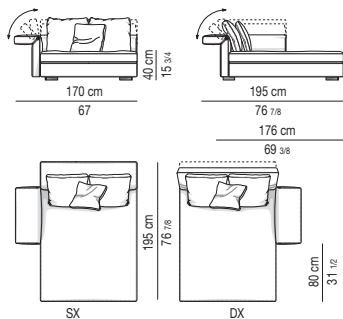

CHAISE-LONGUE CM 170X195 - BRACCIOLO CM 160
CHAISE-LONGUE CM 170X195 - ARMREST CM 160

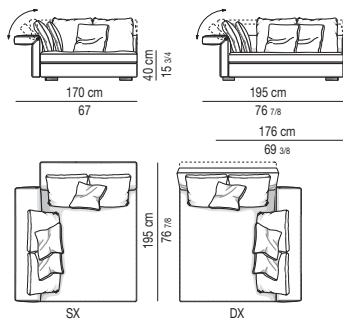

COUCH

COUCH CM 80X170

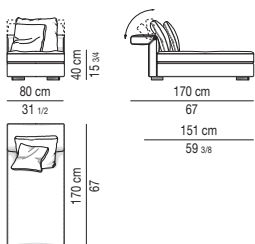

COUCH CM 80X195

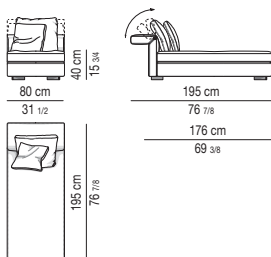

ALTEZZE | HEIGHTS

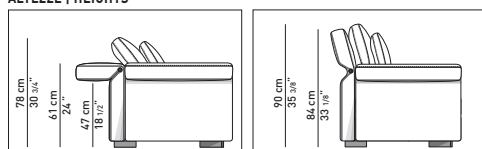

COUCH CM 100X195

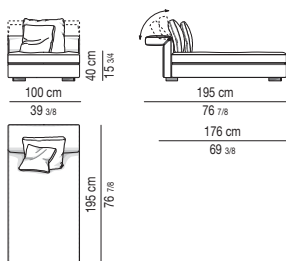

COUCH CM 120X155

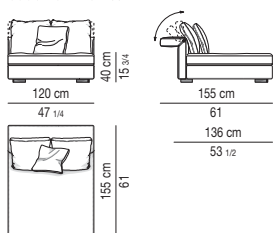

COUCH CM 135X170

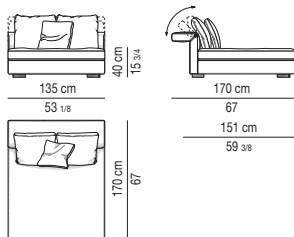

COUCH CM 135X195

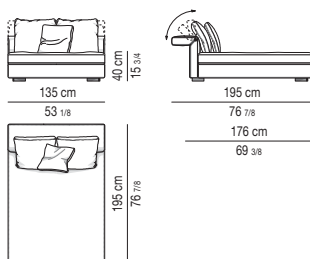

DIVANI CHAISE-LONGUE | CHAISE-LONGUE SOFAS

DIVANO CHAISE-LONGUE CM 115X195
CHAISE-LONGUE SOFA CM 115X195

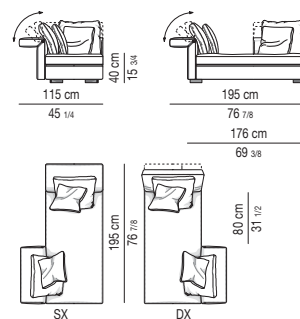

DIVANO CHAISE-LONGUE CM 135X195
CHAISE-LONGUE SOFA CM 135X195

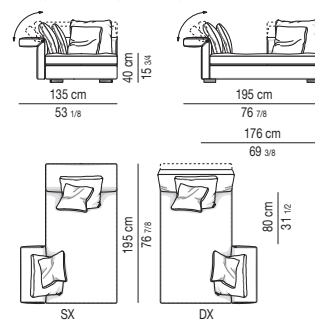

DIVANO CHAISE-LONGUE CM 170X170
CHAISE-LONGUE SOFA CM 170X170

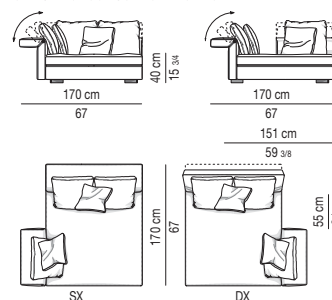

DIVANO CHAISE-LONGUE CM 170X195
CHAISE-LONGUE SOFA CM 170X195

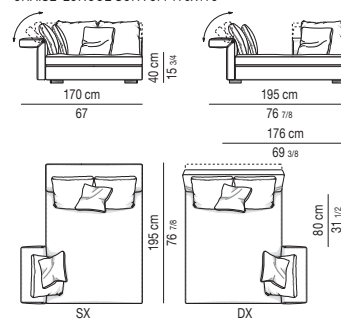

ELEMENTI TERMINALI PENISOLA | OPEN-END ELEMENTS WITH ARMREST

ELEMENTO TERMINALE PENISOLA CM 195 - SCHIENALE CM 80
OPEN-END ELEMENT WITH ARMREST CM 195 - BACKREST CM 80

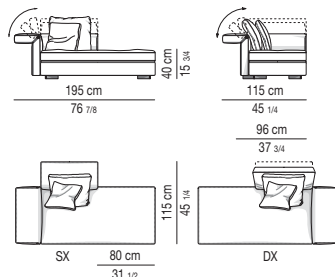

ELEMENTO TERMINALE PENISOLA CM 195 - SCHIENALE CM 120
OPEN-END ELEMENT WITH ARMREST CM 195 - BACKREST CM 120

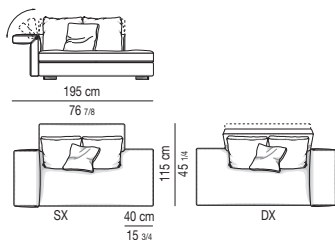

ELEMENTO TERMINALE PENISOLA CM 240 - SCHIENALE CM 100
OPEN-END ELEMENT WITH ARMREST CM 240 - BACKREST CM 100

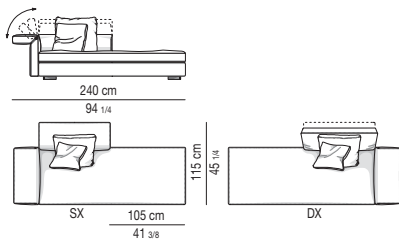

ELEMENTO TERMINALE PENISOLA CM 240 - SCHIENALE CM 160
OPEN-END ELEMENT WITH ARMREST CM 240 - BACKREST CM 160

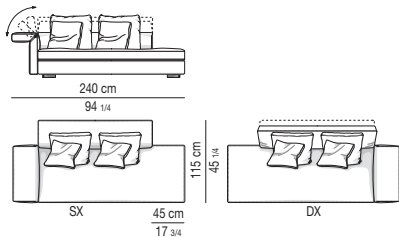

ELEMENTO TERMINALE PENISOLA CM 280 - SCHIENALE CM 120
OPEN-END ELEMENT WITH ARMREST CM 280 - BACKREST CM 120

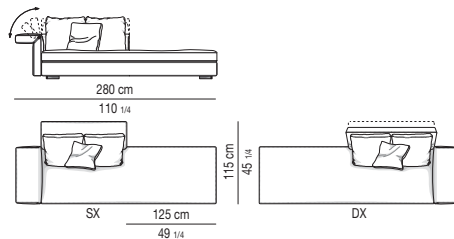

ELEMENTO TERMINALE PENISOLA CM 280 - SCHIENALE CM 160
OPEN-END ELEMENT WITH ARMREST CM 280 - BACKREST CM 160

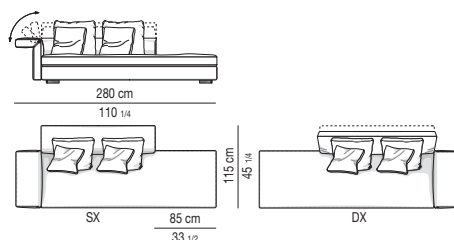

ELEMENTI PENISOLA | OPEN-END ELEMENTS

ELEMENTO PENISOLA CM 160 - SCHIENALE CM 80
OPEN-END ELEMENT CM 160 - BACKREST CM 80

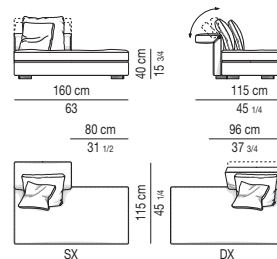

ELEMENTO PENISOLA CM 160 - SCHIENALE CM 120
OPEN-END ELEMENT CM 160 - BACKREST CM 120

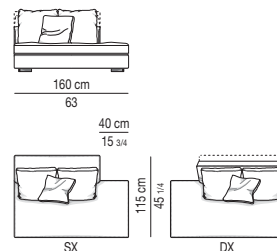

ELEMENTO PENISOLA CM 205 - SCHIENALE CM 100
OPEN-END ELEMENT CM 205 - BACKREST CM 100

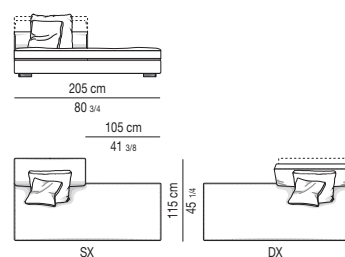

ELEMENTO PENISOLA CM 205 - SCHIENALE CM 160
OPEN-END ELEMENT CM 205 - BACKREST CM 160

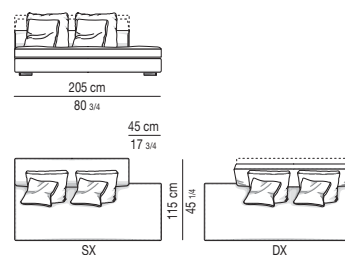

ALTEZZE | HEIGHTS

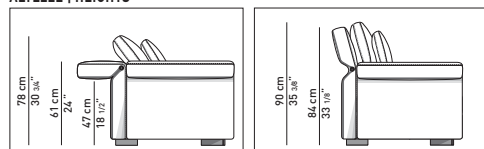

ELEMENTO PENISOLA CM 245 - SCHIENALE CM 120
OPEN-END ELEMENT CM 245 - BACKREST CM 120

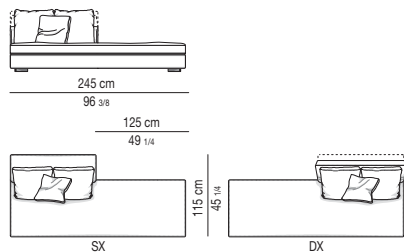

ELEMENTO PENISOLA CM 245 - SCHIENALE CM 160
OPEN-END ELEMENT CM 245 - BACKREST CM 160

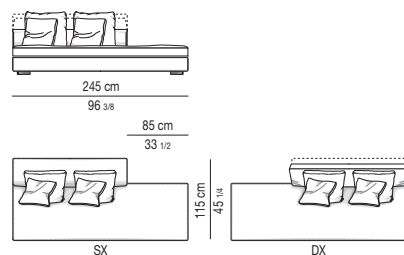

ELEMENTI CENTRALI | CENTRAL ELEMENTS

ELEMENTO CENTRALE CM 100
CENTRAL ELEMENT CM 100

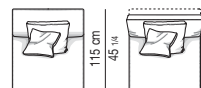
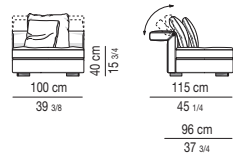

ELEMENTO CENTRALE CM 120
CENTRAL ELEMENT CM 120

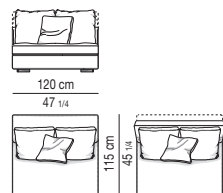

ELEMENTO CENTRALE CM 135
CENTRAL ELEMENT CM 135

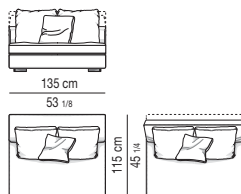

ELEMENTO CENTRALE CM 160
CENTRAL ELEMENT CM 160

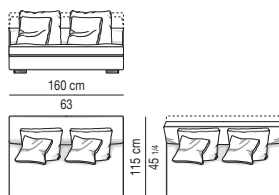

ELEMENTO CENTRALE CM 205
CENTRAL ELEMENT CM 205

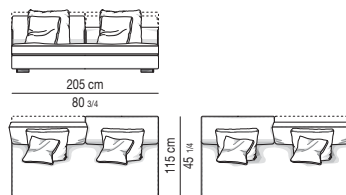

ELEMENTO CENTRALE CM 245
CENTRAL ELEMENT CM 245

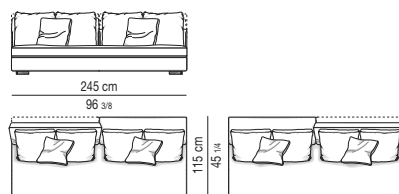

POUF CM 80X80
OTTOMAN CM 80X80

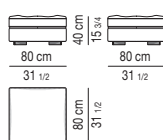

CUSCINO SCHIENALE OPTIONAL "COLLAR"
"COLLAR" OPTIONAL BACK CUSHION



CUSCINO OPTIONAL "COLLAR"
"COLLAR" OPTIONAL CUSHION



CUSCINO OPTIONAL "CLAIRE"
"CLAIRE" OPTIONAL CUSHION



ALTEZZE | HEIGHTS

