

IC C/W I

Specific remark	(*) not dimmable light source
Mounting	Ceiling and wall
Lamps description	1 x 60W E14 HSGS or 1 LED 8W E14 800lm 3000K (*)
Environment	Indoor
Finish	Brushed brass, Chrome
Technical description	Wall-ceiling lamp providing diffused light. Frame in brass, brushed and transparent varnished or chrome steel. Blown glass opal diffuser.



ELECTRICAL

Emergency	Without
------------------	---------

PHYSICAL



Construction material	Blown glass, Brass, Steel
Weight (kg)	2.0



IC C/W I

designed by Michael Anastassiades

Wall-ceiling lamp providing diffused light.

	F3178057	Chrome
	F3178059	Brushed brass

DIMENSIONS

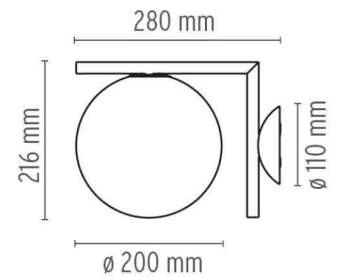

CERTIFICATIONS



IP
20

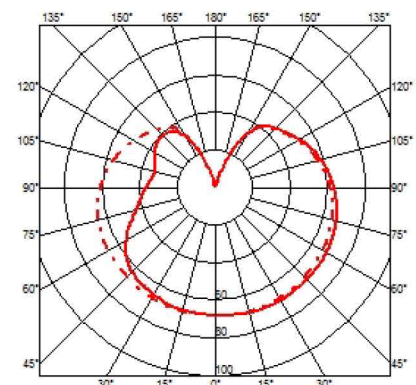

IC C/W I . Lamps



HSGS 60W E14

Lamp wattage:
60 W

Lamp category:
Halogen mains

Socket:
E14

Lamp type:
HSGS

LED 8W E14 800lm 3000K

Lamp wattage:
8 W

Lamp category:
LED

Socket:
E14

Color temperature (K):
3000 °K



Lamp type:
LED



IC C/W I

designed by Michael Anastassiades

Wall-ceiling lamp providing diffused light.

-  F3178057 Chrome
-  F3178059 Brushed brass

DIMENSIONS

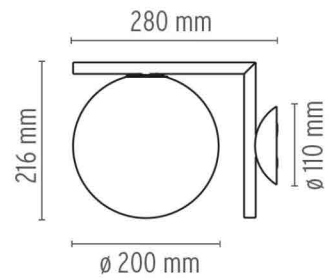

CERTIFICATIONS



IP
20

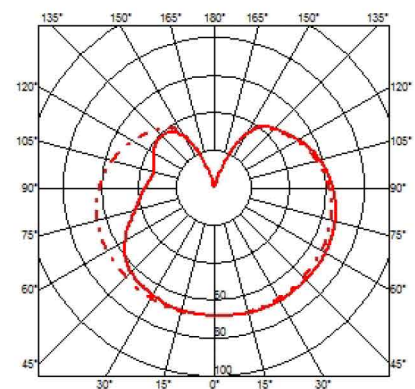

IC C/W 2

Mounting	Ceiling and wall
Lamps description	1 x 205W E27 HSGS or 1 LED 13W E27 1400lm 3000K
Environment	Indoor
Finish	Brushed brass, Chrome
Technical description	Wall-ceiling lamp providing diffused light. Frame in brass, brushed and transparent varnished or chrome steel. Blown glass opal diffuser.

ELECTRICAL

Emergency	Without
------------------	---------

PHYSICAL



Construction material	Blown glass, Brass, Steel
Weight (kg)	3.7



IC C/W 2

designed by Michael Anastassiades

Wall-ceiling lamp providing diffused light.

	F3179057	Chrome
	F3179059	Brushed brass

DIMENSIONS

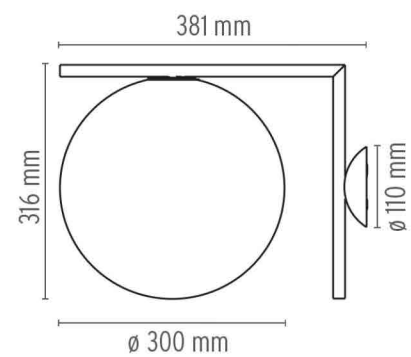

CERTIFICATIONS



IP
20

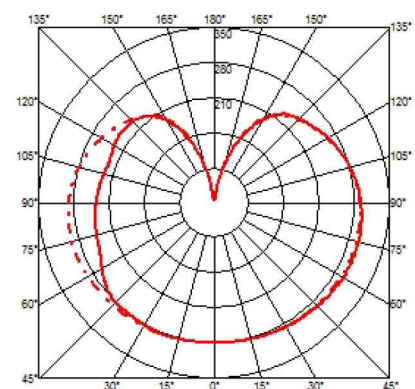

IC C/W 2 . Lamps



HSGS 205W E27

Lamp wattage:
205 W

Lamp category:
Halogen mains

Socket:
E27

Lamp type:
HSGS

LED 13W E27 1400lm 3000K

Lamp wattage:
13 W

Lamp category:
LED

Socket:
E27

Color temperature (K):
3000 °K

Lamp type:
LED



IC C/W 2

designed by Michael Anastassiades

Wall-ceiling lamp providing diffused light.

 F3179057 Chrome

 F3179059 Brushed brass

DIMENSIONS

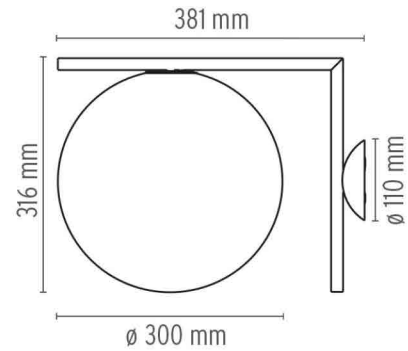

CERTIFICATIONS

