

Pillow Vico Magistretti 2004



Divano a due o più posti e divano componibile

Materiali:

STRUTTURA: acciaio e legno con cinghie elastiche.

PIEDINI: acciaio verniciato a polvere con sottopiede regolabile in materiale termoplastico.

IMBOTTITURA: poliuretano espanso a quote differenziate e ovatta di poliestere rivestito con vellutino di poliestere e tela di cotone. Per le versioni FR (Fire Resistant) a richiesta, i materiali dell'imbottitura sono come da normative.

CUSCINO DI SEDUTA E CUSCINO SCHIENALE: piuma d'oca mista a particelle di poliuretano espanso rivestito con tela di cotone.

CUSCINO VOLANTE: piuma d'oca rivestito con tela di cotone.

RIVESTIMENTO ESTERNO: rivestimento tecnicamente sfoderabile in tessuto o fisso in velluto.

+info:

<http://www.depadova.com/materials.pdf>

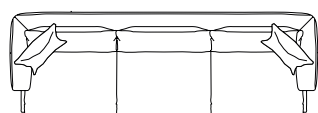
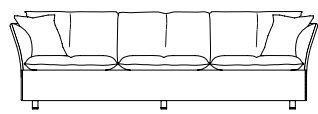
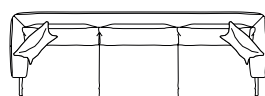
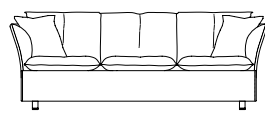
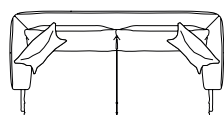
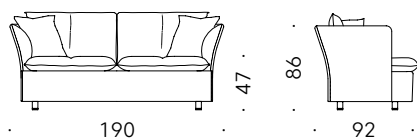

Esempi di composizione

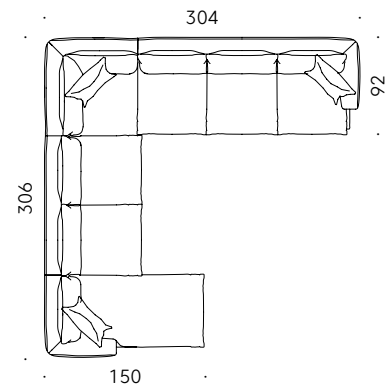
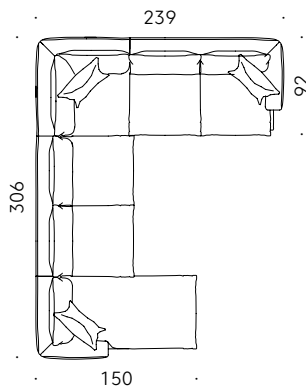
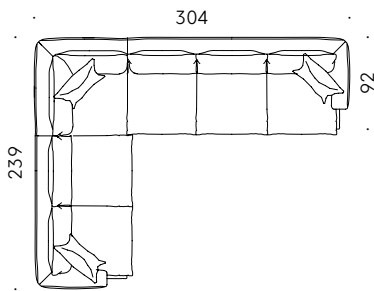
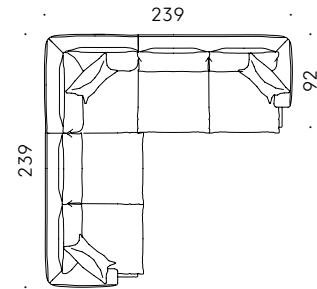
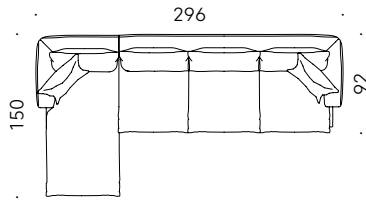
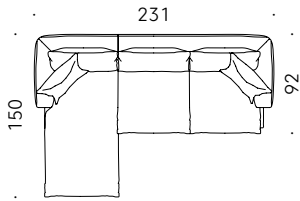

Pillow Vico Magistretti 2004



Two or more-seater sofa and modular sofa

Materials:

FRAME: steel and wood with elastic straps.

FEET: powder-coated steel, with adjustable thermoplastic glide feet.

PADDING: variable-density foamed polyurethane and polyester wadding, covered with polyester velveteen and cotton cloth. For FR (Fire Resistant) versions, padding materials follow current regulations.

SEAT AND BACKREST CUSHION: in goose down mixed with polyurethane foam particles, covered with cotton cloth.

LOOSE CUSHION: in goose down covered with cotton cloth.

EXTERNAL COVER: totally removable cover in fabric or non-removable in velvet.

+info:

<http://www.depadova.com/materials.pdf>

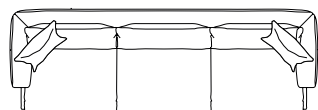
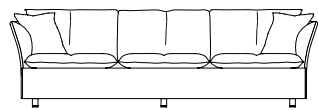
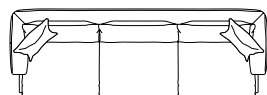
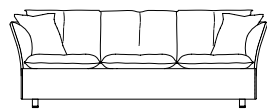
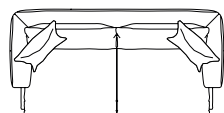
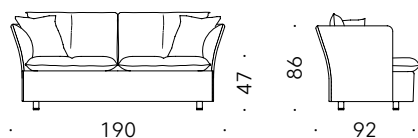

Composition Examples

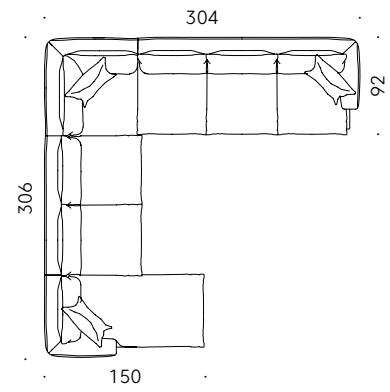
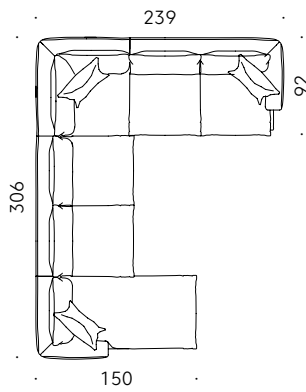
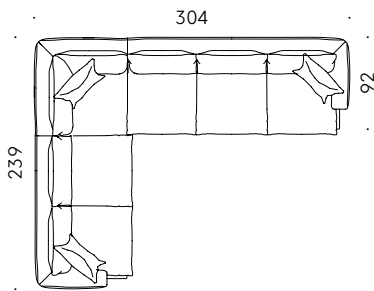
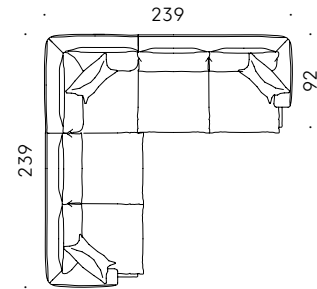
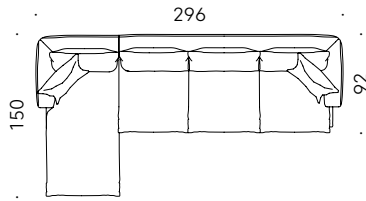
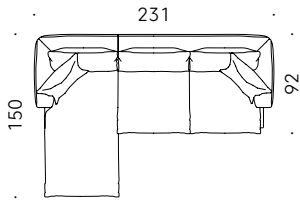

Pillow Vico Magistretti 2004

Canapé à deux places ou plus et canapé modulable

Matériaux:

STRUCTURE: acier et bois avec sangles élastiques.

PIEDS: acier peint noir mat à poudre avec patin réglables en thermoplastique.

REMOBLEMENT: mousse de polyuréthane à densité variable et ouate de polyester revêtue avec velours de polyester et toile de coton. Pour les versions FR (Fire Resistant) sur demande, les matériaux du rembourrage sont conformes aux réglementations.

COUSSIN D'ASSISE ET COUSSIN DE DOSSIER: plume d'oie mixte avec particules de mousse de polyuréthane revêtue avec toile de coton.

COUSSIN AMOVIBLE: plume d'oie revêtue avec toile de coton.

REVÊTEMENT EXTERNE: revêtement techniquement déhoussable en tissu ou fixe en velours.

+info:

<http://www.depadova.com/materials.pdf>

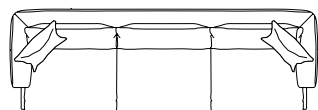
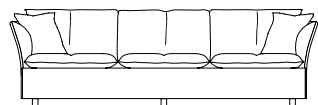
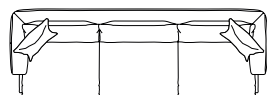
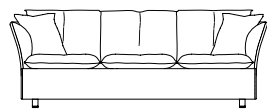
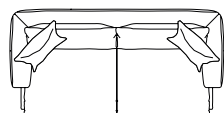
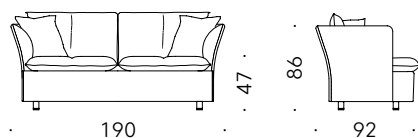

Exemples de composition

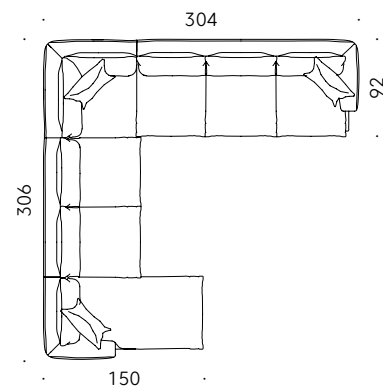
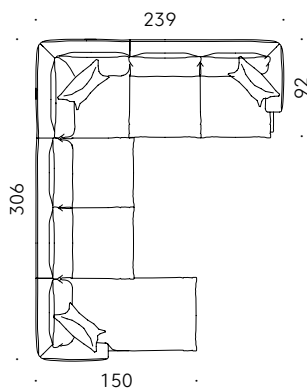
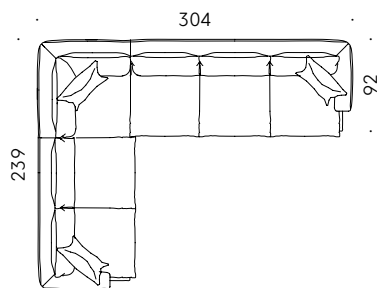
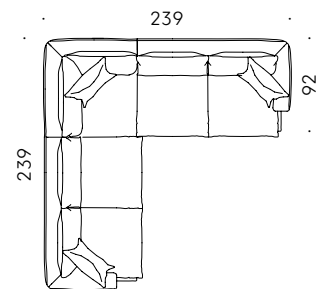
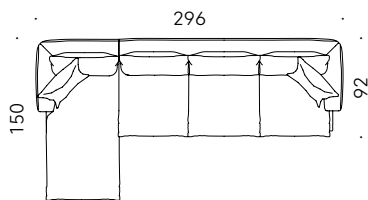
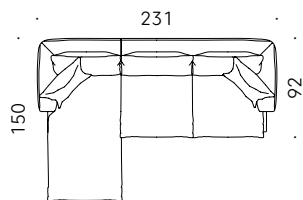

Pillow Vico Magistretti 2004



Zwei- oder mehrsitziges Sofa und modulares Sofa

Materialien:

GESTELL: Stahl und Holz mit elastischen Gurten.

FÜßE: Pulverlackierter Stahl, mit verstellbaren Thermoplast-Gleitfüßen.

POLSTERUNG: Polyurethanschäum unterschiedlicher Dichte und Polyesterwatte, mit Überzug aus Polyestersamt und Baumwollgewebe. Bei den FR-Versionen (Fire Resistant) entsprechen die Polstermaterialien den geltenden Bestimmungen.

SITZKISSEN UND RÜCKENLEHNENKISSEN: Gänsedaunen gemischt mit Polyurethanschäum und Überzug aus Baumwollgewebe.

LOSE KISSEN : Gänsedaunen mit Überzug aus Baumwollgewebe.

AUBENBEZUG: abnehmbarer Stoffbezug oder fester Samtbezug.

+info:

<http://www.depadova.com/materials.pdf>

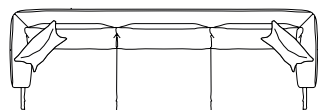
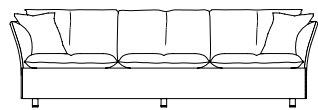
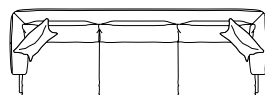
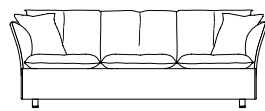
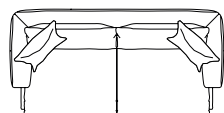
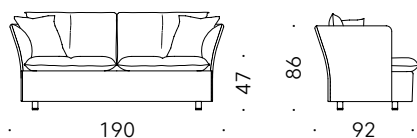

Kompositionsbeispiele

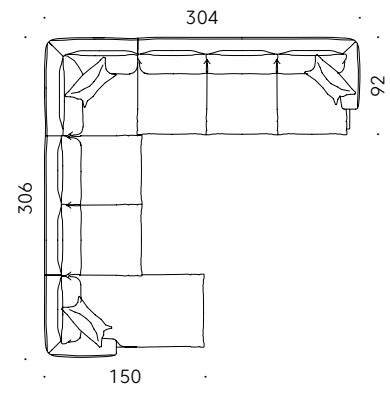
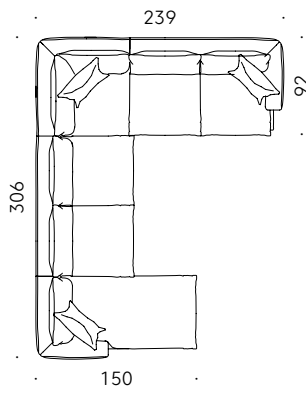
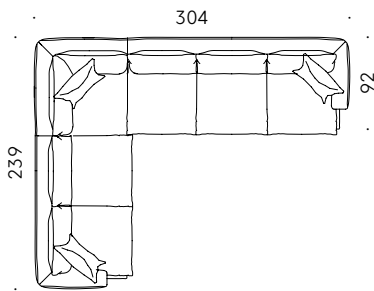
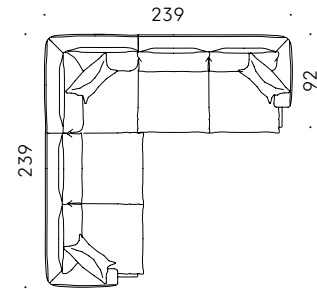
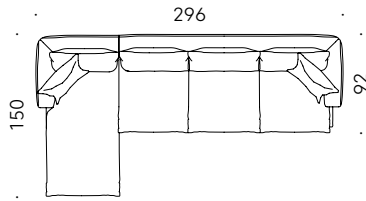
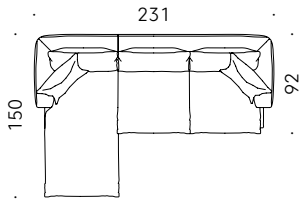

Pillow Vico Magistretti 2004



Sofá de dos o más plazas y sofá modular

Materiales:

ESTRUCTURA: acero y madera con cinchas elásticas.

PIES: acero pintado en polvo con bajo-pies ajustables de material termoplástico.

RELLENO: espuma de poliuretano de densidad diferente y guata de poliéster revestida con terciopelo de poliéster y tela de algodón. Para las versiones FR (Fire Resistant) bajo pedido, los materiales del relleno cumplen con las normativas.

COJÍN DE ASIENTO Y COJÍN DE RESPALDO: plumas de oca mixtas con partículas de espuma de poliuretano revestidas con tela de algodón.

COJÍN SUELTO: plumas de oca revestidas con tela de algodón.

TAPIZADO EXTERIOR: tapizado técnicamente desenfundable de tejido o fijo de terciopelo.

+info:

<http://www.depadova.com/materials.pdf>

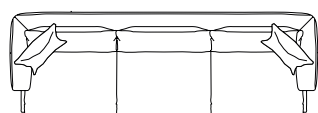
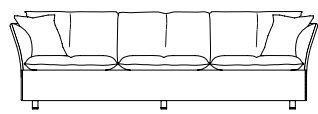
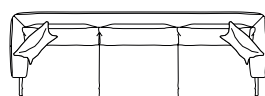
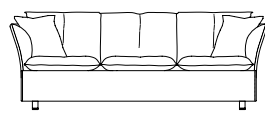
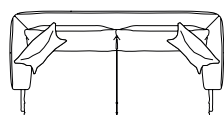
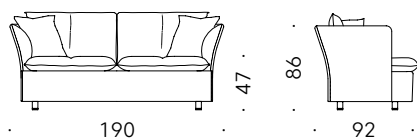

Ejemplos de composición

